

ACO Access Cover UNIFACE 1.0 / 2.0 (FI 2.0 Flex)

1

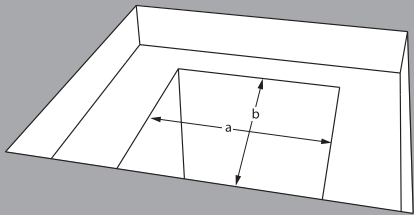

2

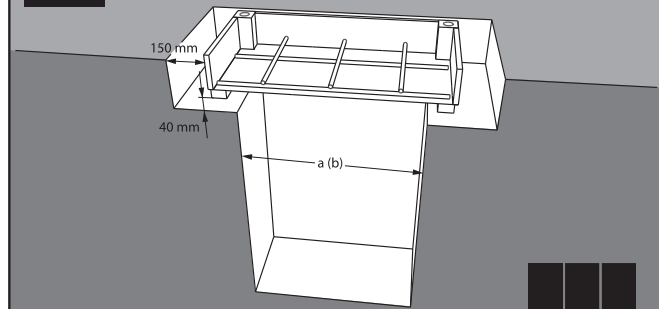

3

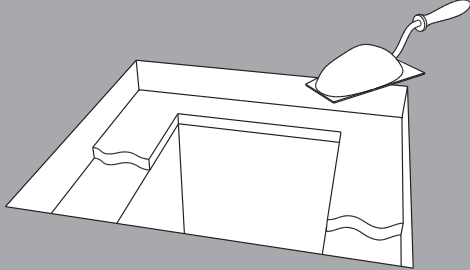

4

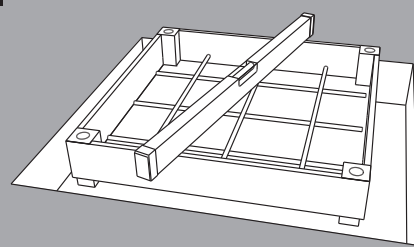

5

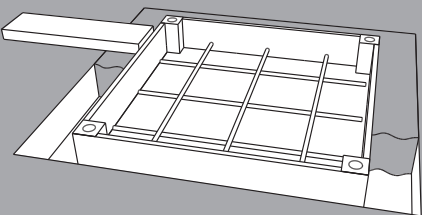

6

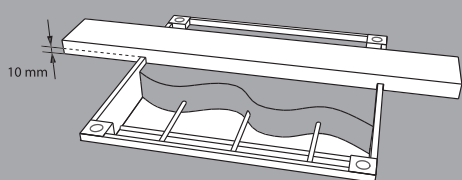

7

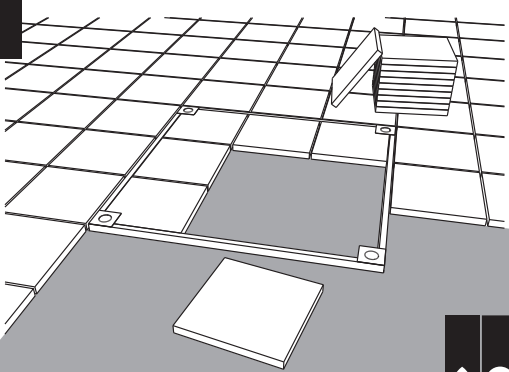

8

